

56/57 54/55 56/59 80/81 62/63 64/65 66/67/68 69/70

PCA4100-0476 WITH TRANSFORMER  
PCA4100-0915 WITHOUT TRANSFORMER

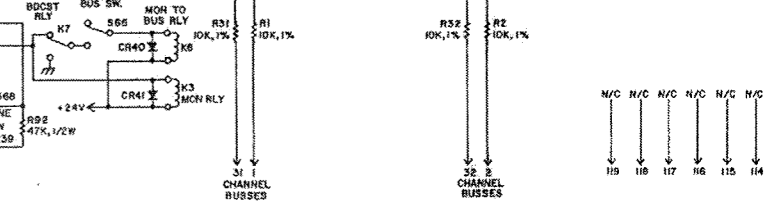
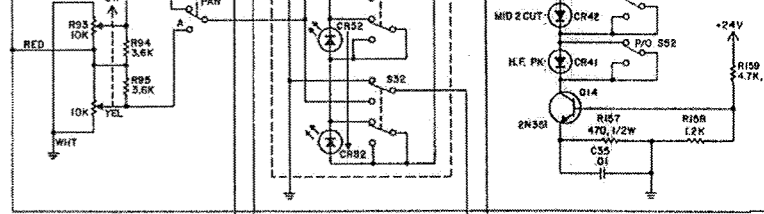
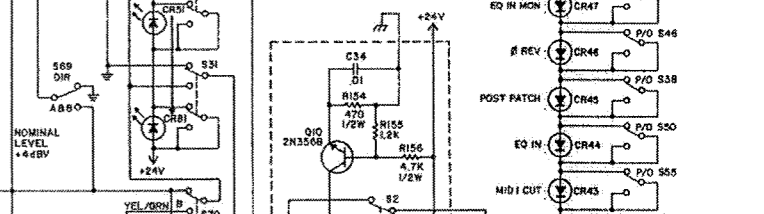
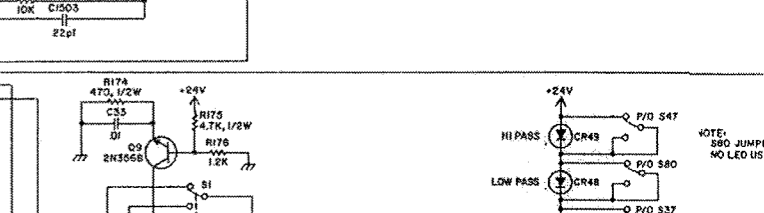
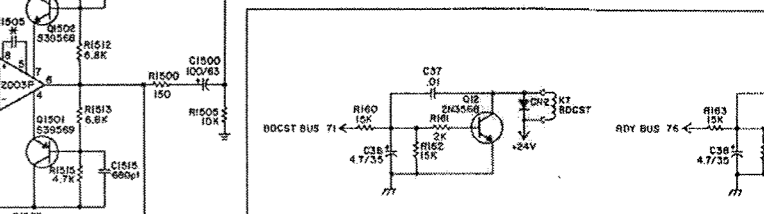
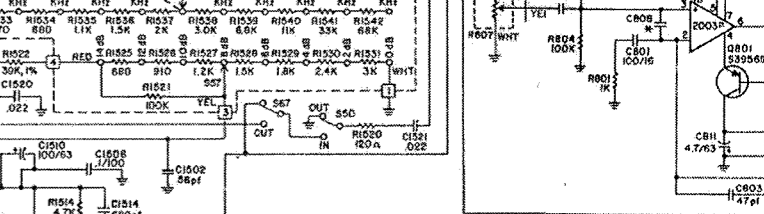
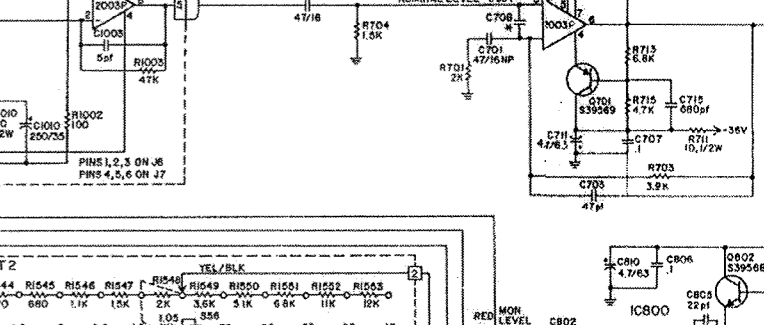
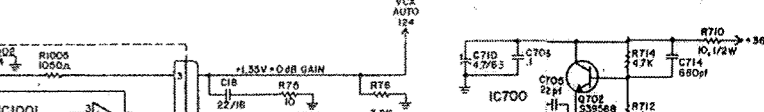
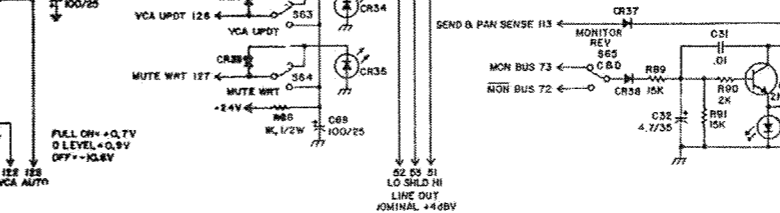
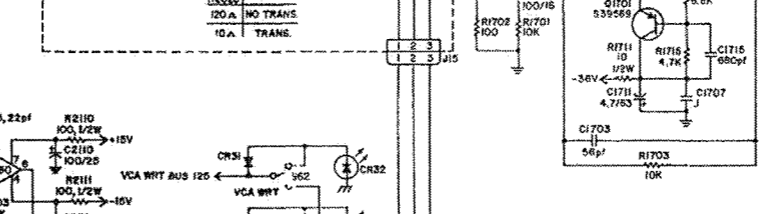
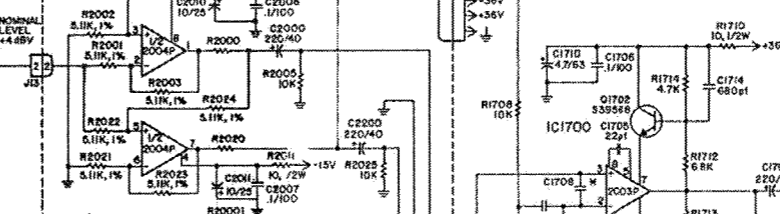
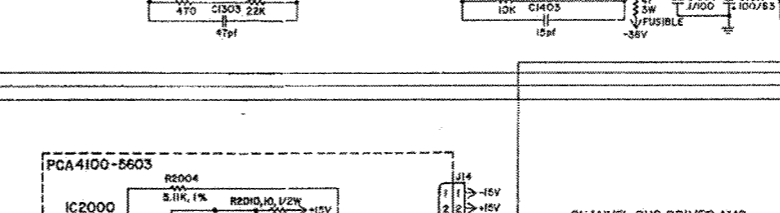
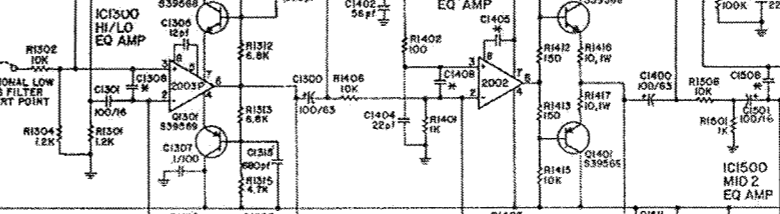
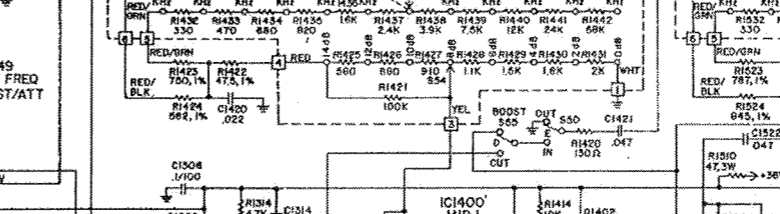
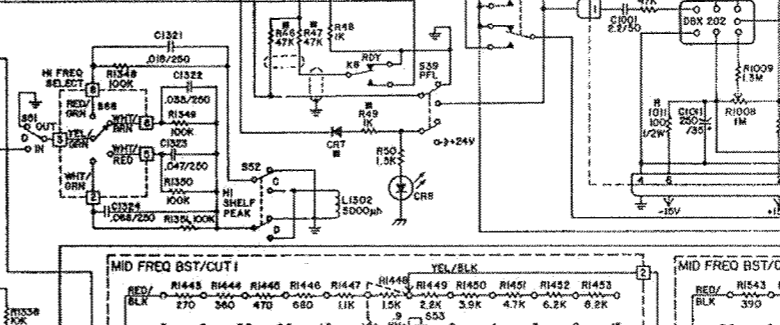
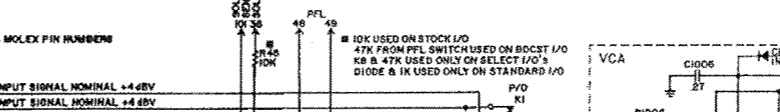
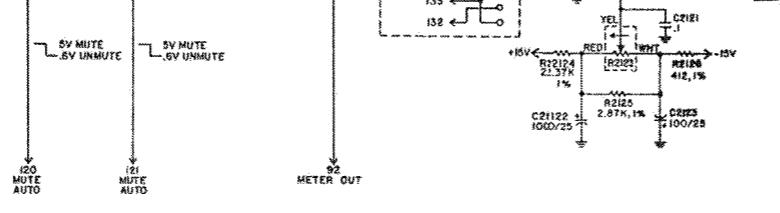
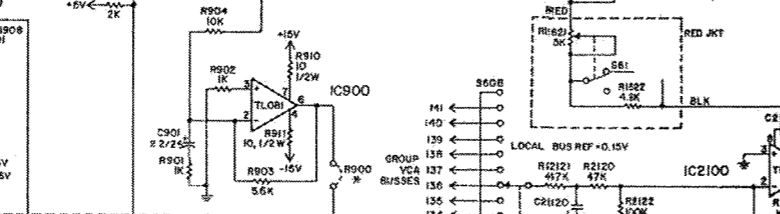
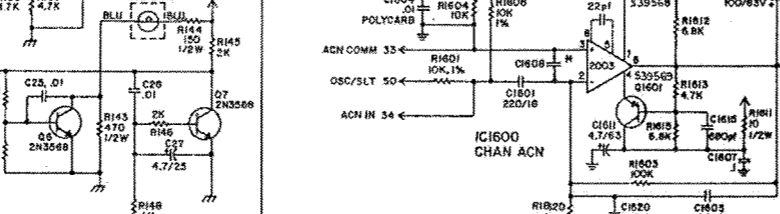
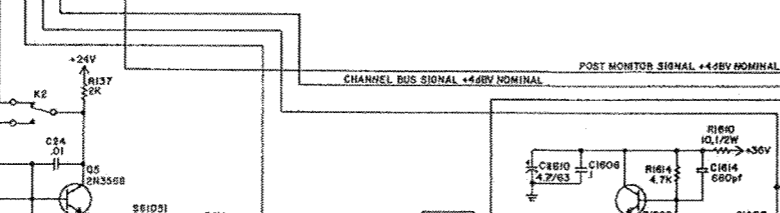
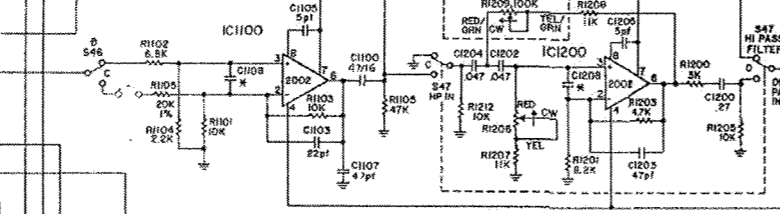
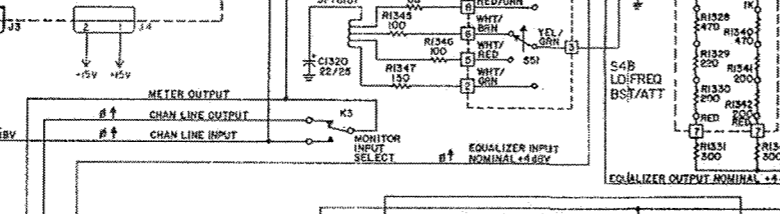
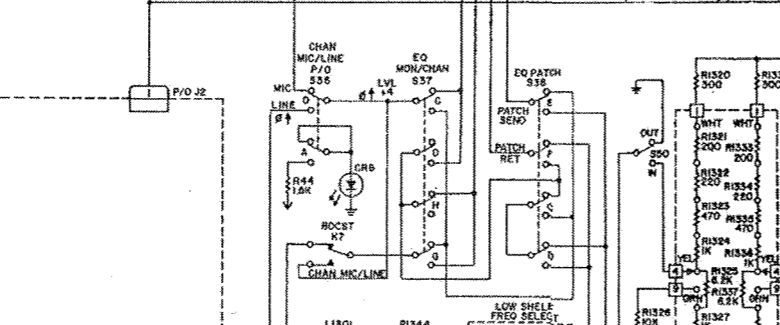
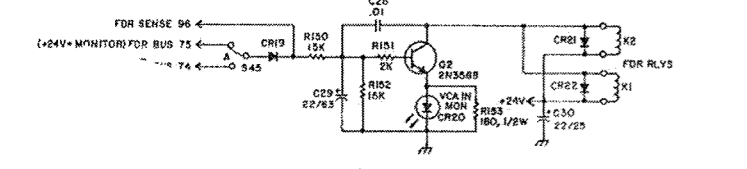
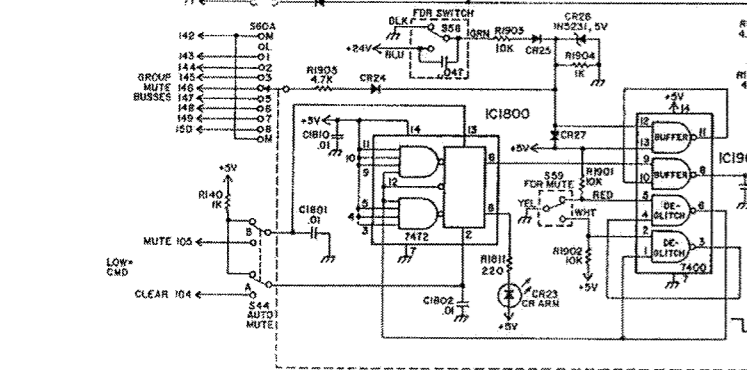
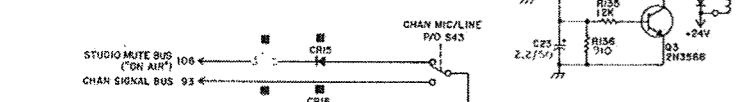
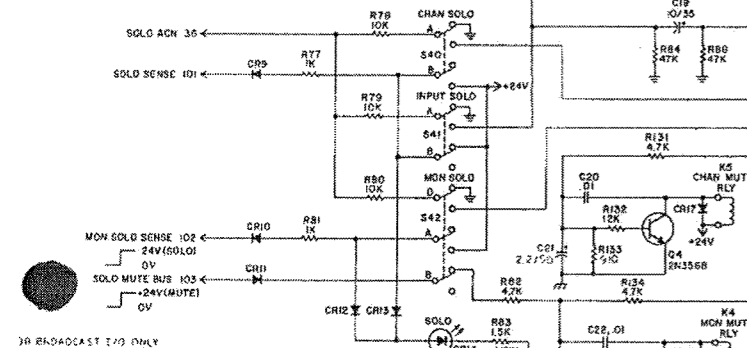
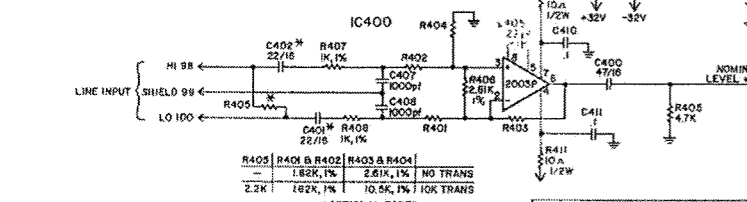
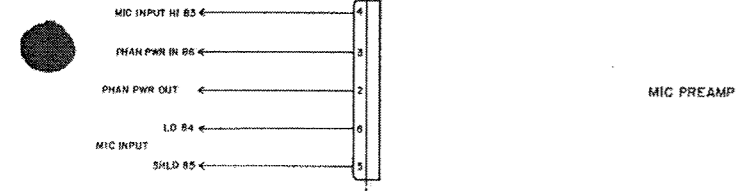

30 BROADCAST TAP ONLY

NOTE: S80 JUMPER NO LED USED

N/C N/C N/C N/C N/C N/C

119 118 117 116 115 114

31 CHANNEL BUSES

32 CHANNEL BUSES

